

# Acumulador Gamma Multiproposito

**Intercambiador Sanitario**  
 Tubo Corrugado A. Inox. AISI 316L - DN32

**iÚnico!**  
 Conex. Resistencia Eléctrica  
 Bombas de Calor

**iÚnico!**  
 Intercambiador Solar  
 Modelo R1

**iÚnico!**  
 Estratificador

**iÚnico!**  
 Eficiencia Clase B

**iÚnico!**  
 Termómetro Incorporado

5 Conexiones de sondas de T° (1.000 LT.)

Producción de ACS instantánea 7m<sup>2</sup> (1.000 LT.)

Modelo	Aislamiento	Eficiencia Clase UE 812/2013	Dispersion (W)	Acumulador		Serp. ACS			Serp. Inferior R1			Peso R0 (kg)	Peso R1 (kg)
				Pmax (bar)	Tmax (°C)	Pmax (bar)	Tmax (°C)	Super. (m <sup>2</sup> )	Pmax (bar)	Tmax (°C)	Super. (m <sup>2</sup> )		
<b>GAMMA 200</b>	PU50mm+PVC	<b>B</b>	61	6	95	10	95	1.5	12	110	0.8	44	55
<b>GAMMA 300</b>	PU50mm+PVC	<b>B</b>	68	6	95	10	95	2.6	12	110	1.2	55	71
<b>GAMMA 500</b>	PU50mm+PVC	<b>B</b>	92	6	95	10	95	4.0	12	110	1.8	104	128
<b>GAMMA 600</b>	Polyester 100mm+PVC	<b>B</b>	113	6	95	10	95	4.0	12	110	1.8	121	145
<b>GAMMA 800</b>	Polyester 100mm+PVC	<b>B</b>	117	6	95	10	95	6.0	12	110	2.4	136	169
<b>GAMMA 1000</b>	Polyester 100mm+PVC	<b>B</b>	144	6	95	10	95	7.5	12	110	3.0	172	202
<b>GAMMA 1250</b>	Polyester 100mm+PVC	<b>B</b>	157	6	95	10	95	7.5	12	110	3.0	191	234
<b>GAMMA 1500</b>	Polyester 100mm+PVC	<b>B</b>	170	6	95	10	95	10.0	12	110	3.6	236	272
<b>GAMMA 2000</b>	Polyester 100mm+PVC	<b>B</b>	204	6	95	10	95	10.0	12	110	4.2	315	366

MADE IN ITALY

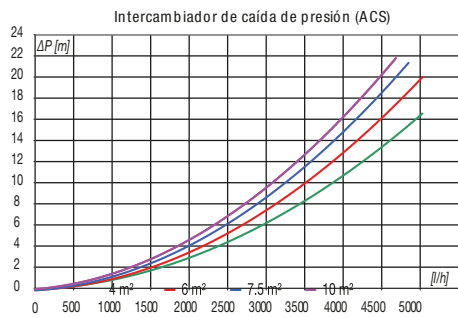

**Norma DIN 4708 a  $\Delta T$  35°C**

GAMMA	200			2.6 m2			300			2.6 m2			500			4 m2			800			6 m2			1000			7.5 m2			1500			10 m2			2000			10 m2		
	T C°	Q (l/h)	$\Delta T$ 35 (l/h)	D 4708 (l/m)	Pot (KW)	$\Delta T$ 35 (l/h)	D 4708 (l/m)	Pot (KW)	$\Delta T$ 35 (l/h)	D 4708 (l/m)	Pot (KW)	$\Delta T$ 35 (l/h)	D 4708 (l/m)	Pot (KW)	$\Delta T$ 35 (l/h)	D 4708 (l/m)	Pot (KW)	$\Delta T$ 35 (l/h)	D 4708 (l/m)	Pot (KW)	$\Delta T$ 35 (l/h)	D 4708 (l/m)	Pot (KW)	$\Delta T$ 35 (l/h)	D 4708 (l/m)	Pot (KW)	$\Delta T$ 35 (l/h)	D 4708 (l/m)	Pot (KW)	$\Delta T$ 35 (l/h)	D 4708 (l/m)	Pot (KW)	$\Delta T$ 35 (l/h)	D 4708 (l/m)	Pot (KW)							
50	2000	245	4	10	425	7	17	654	11	27	980	16	40	1226	20	50	1635	27	67	2180	27	67																				
60	2000	477	8	19	827	14	34	1273	21	52	1909	32	78	2387	40	97	3183	53	130	4244	53	130																				
70	2000	705	12	29	1222	20	50	1881	31	77	2821	47	115	3526	59	144	4701	79	191	6268	79	191																				
80	2000	894	15	36	1550	26	63	2385	40	97	3578	60	146	4472	75	182	5963	100	243	7950	100	243																				

**Esquema 3 acumuladores en paralelo : Producción de ACS y CALEFACCIÓN**

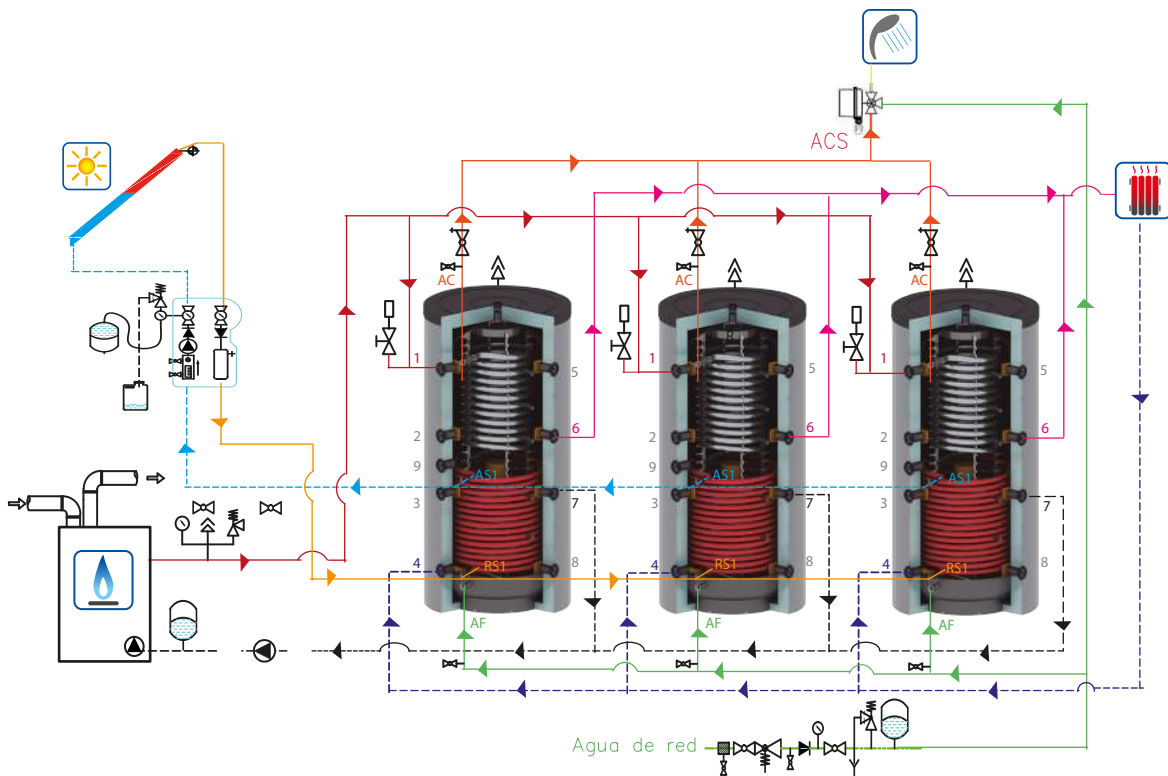

- |                              |      |                              |      |                      |      |
|------------------------------|------|------------------------------|------|----------------------|------|
| 1 Entrada de Caldera         | 1/2" | 6 Salida Calefacción Baja T° | 1/2" | S Sonda              | 1/2" |
| 2 Libre                      | 1/2" | 7 Retorno de Caldera         | 1/2" | R1 Retorno Solar     | 1"   |
| 3 Libre                      | 1/2" | 8 Libre                      | 1/2" | A1 Entrada Solar     | 1"   |
| 4 Retorno Calefacción        | 1/2" | 9 Conexión Resistencia       | 1/2" | AF Entrada Agua Fría | 1"   |
| 5 Salida Calefacción Alta T° | 1/2" |                              |      | AC Salida de ACS     | 1"   |

**GAMMA - R0**

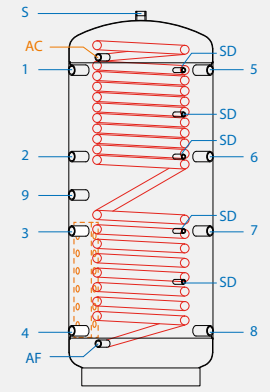

**GAMMA - R1**

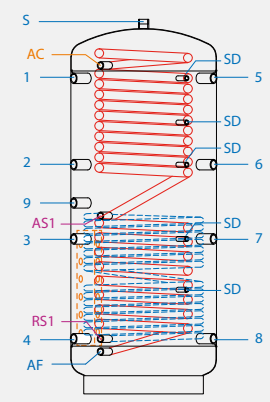

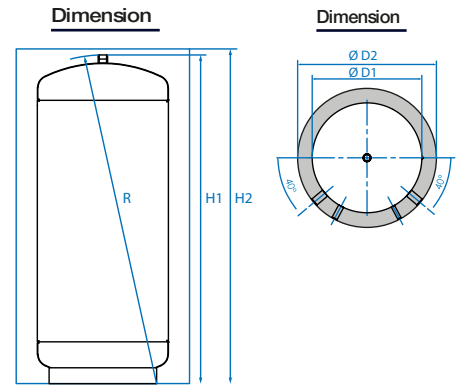

**Dimensiones**

Modelo	1-5	2-6	3-7	4-8	9	AF	AC	RS1	AS1	Ø D1	Ø D2	R	H1	H2
200	960	685	585	210	821	125	1066	210	520	500	600	1339	1182	1197
300	1108	758	658	208	758	124	1292	208	658	550	650	1505	1342	1357
500	1381	971	651	211	821	136	1455	211	721	650	750	1794	1621	1630
600	1394	994	594	224	804	149	1468	224	724	700	900	1673	1643	1700
800	1426	1026	626	256	866	181	1500	256	801	790	990	1720	1685	1760
1000	1720	1249	844	300	1040	220	1800	300	970	790	990	2069	2040	2090
1250	1700	1239	784	300	1085	211	1789	300	970	950	1150	2061	2014	2060
1500	1750	1285	900	350	1128	261	1839	350	1000	1000	1200	2193	2149	2200
2000	2025	1489	959	325	1214	235	2114	325	1105	1100	1300	2431	2374	2420

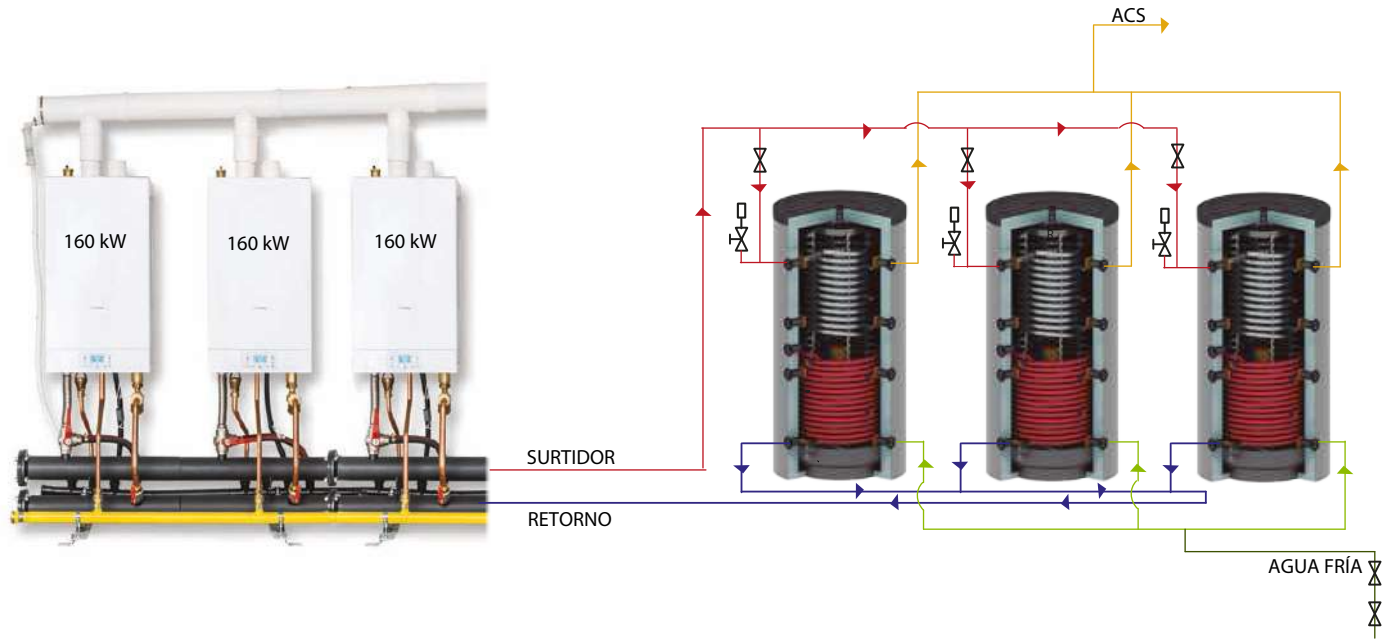

**Esquema 2: CONEXIÓN DIRECTA - ONE BY ONE/ TODOS**



- 1.- Los acumuladores GAMMA deben conectarse paralelamente con retorno INVERTIDO, así asegura que la carga sea simultánea.
- 2.-  : Válvula motorizada, activa sistema según temperaturas ( 1 unidad o N unidades) de caldera.
- 3.- Opcional Conexión caldera una a una o en cascada.

**Esquema 3: CONEXIÓN CON SEPARADOR HIDRÁULICO**

